

ILLUSTRATED PARTS LIST

MODEL NUMBER M3750SM

PRODUCT NUMBER 961 11 00-16

MFG. ID. NUMBER 96111001601

ROTARY LAWN MOWER -- MODEL NUMBER M3750SM (96111001601) PRODUCT NUMBER 961 11 00-16

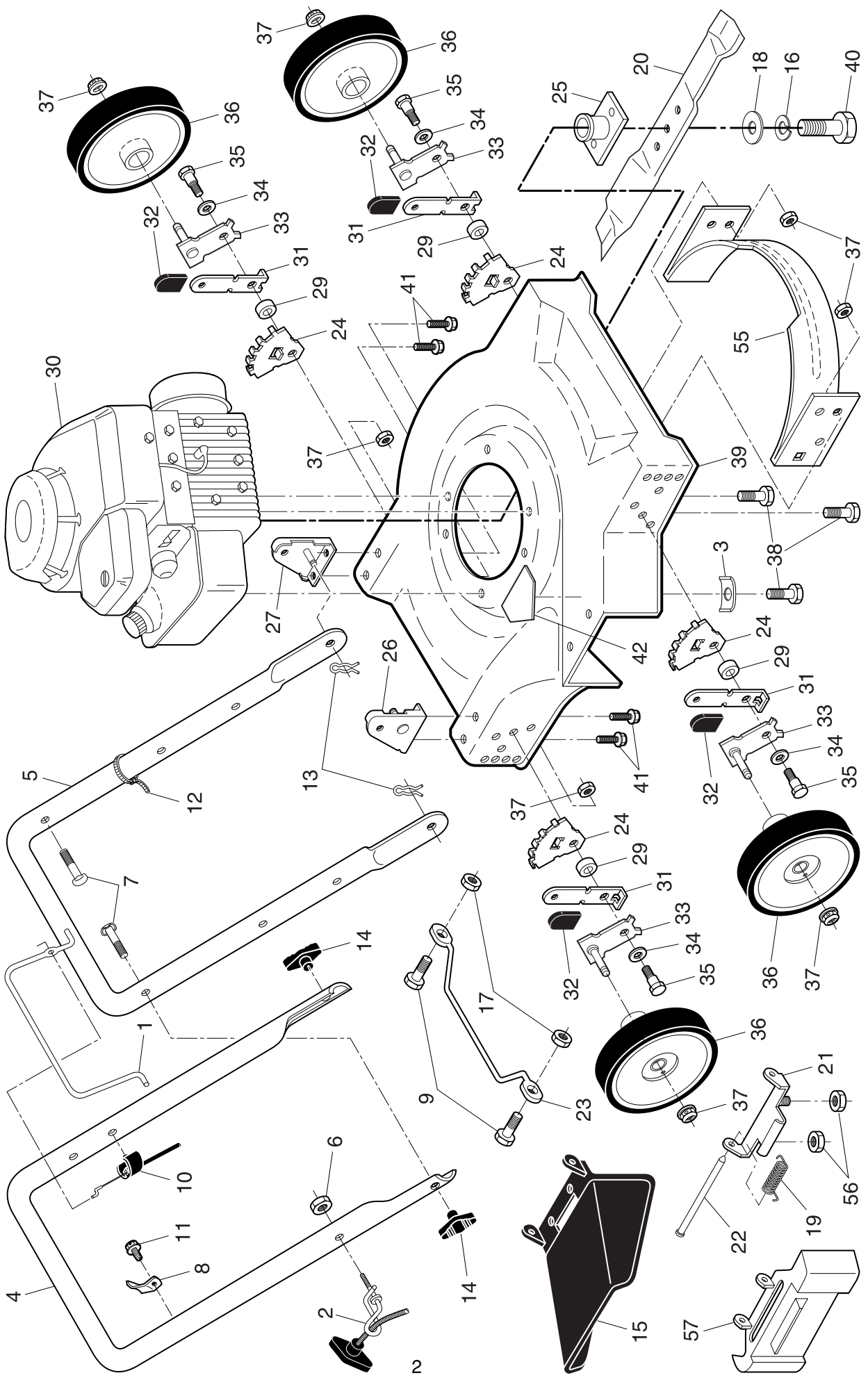

ROTARY LAWN MOWER - - MODEL NUMBER M3750SM (96111001601) PRODUCT NUMBER 961 11 00-16

KEY NO.	PART NO.	DESCRIPTION	KEY NO.	PART NO.	DESCRIPTION
1	532 19 60-25	Control Bar	25	532 85 09-77	Blade Adapter
2	532 19 47-88	Rope Guide	26	532 17 09-75	Handle Bracket, RH
3	532 12 50-78	Washer, Engine	27	532 17 09-77	Handle Bracket, LH
4	532 19 60-26	Upper Handle	29	532 14 66-30	Spacer
5	532 15 50-44	Lower Handle	30	- - -	Engine, Briggs & Stratton, Model Number 9D902 (Order parts from engine manufacturer)
6	532 13 20-04	Locknut, Hex 1/4-20	31	532 14 17-30	Spring, Selector
7	532 19 15-74	Bolt 1/4-20	32	532 08 78-77	Knob, Selector
8	532 12 52-03	Up-Stop Bracket	33	532 14 98-57	Axle Arm Assembly
9	532 08 58-25	Screw	34	532 06 23-35	Washer
10	532 16 27-78	Engine Zone Control Cable	35	532 14 27-48	Shoulder Bolt
11	532 75 06-34	Screw, Self-Tapping, Hex Washer Head #10-24 x 1/2	36	532 40 61-55	Wheel & Tire Assembly 8 x 1-3/4
12	532 06 64-26	Wire Tie	37	532 75 15-92	Locknut, Hex 5/8-16
13	532 05 17-93	Hairpin Cotter	38	532 15 04-06	Screw, Hex Head, Threaded, Rolled 3/8-16 x 1
14	532 19 19-38	Handle Knob	39	532 40 07-34	Kit, Lawn Mower Housing
15	532 75 20-52	Discharge Guard	40	532 85 10-84	Screw, Machine, Hex Head 3/8-24 x 1-3/8 Grade 8
16	532 85 02-63	Helical Lock Washer	41	532 14 97-41	Screw
17	532 06 91-80	Nut, Hex	42	532 18 21-66	Danger Decal
18	532 85 10-74	Washer, Hardened	55	532 14 15-19	Front Baffle
19	532 19 30-00	Spring, Hinge	56	873 80 04-00	Nut, Hex
20	532 14 51-06	Blade, 20"	57	532 19 33-60	Mulcher Plug
21	532 08 86-02	Hinge Bracket	- -	532 14 15-20	Rear Baffle (not shown)
22	532 15 02-15	Hinge Rod	- -	532 40 04-69	Operator's Manual, European
23	532 15 41-47	Foot Guard	- -	532 40 04-71	Operator's Manual, Scandinavian
24	532 14 23-28	Bracket, Wheel Adjusting	- -	532 40 04-74	Operator's Manual, East Bloc
			- -	532 40 04-73	Operator's Manual, Baltic

NOTE: All component dimensions given in U.S. inches. 1 inch = 25.4 mm. **IMPORTANT:** Use only Original Equipment Manufacturer (O.E.M.) replacement parts. Failure to do so could be hazardous, damage your lawn mower and void your warranty.